

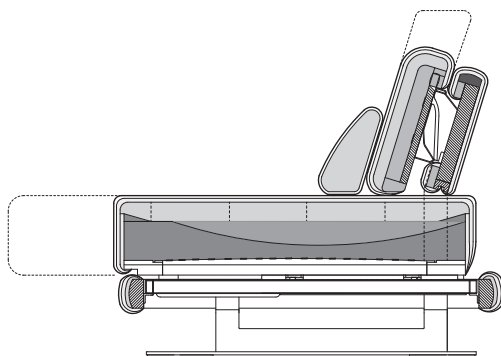

- Leg: Steel, optionally with a structured silver or grey-brown paintwork finish
 - Metal base frame with integrated pull-forward function
 - Seat with pull-forward capability
 - Seat with wooden inner frame
 - Seat heights: there are two seat heights: 42 cm or 44 cm
 - Nosag spring support
 - Upholstered bench without sub-springing
 - Seat in polyurethane foam, built up in coordinated layers varying in height and firmness, covered with a downy-soft mat worked into ticking chambers and filled with foam rods and polyester fibres
 - Backrest cushions height adjustable
 - Back in polyurethane foam, covered in a downy-soft mat worked into ticking chambers and filled with foam rods and polyester fibres
 - Downy-soft cushions, worked into ticking chambers with a filling of foam rods and felt made of polyester fibre
- ▼ Wave formation and depressions in the seat area are unavoidable, due to
- comfort and design reasons, even in high quality Rolf Benz upholstered furniture.
- All measurements are approximate.



Seat heights available

Sofa seat width 147 cm*

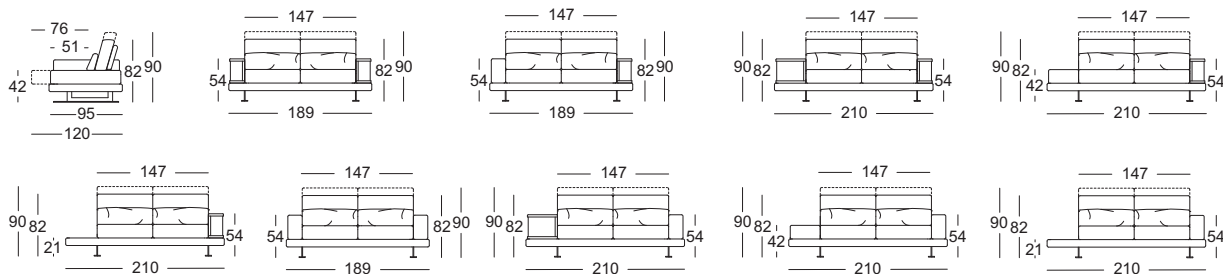

Sofa seat width 168 cm*

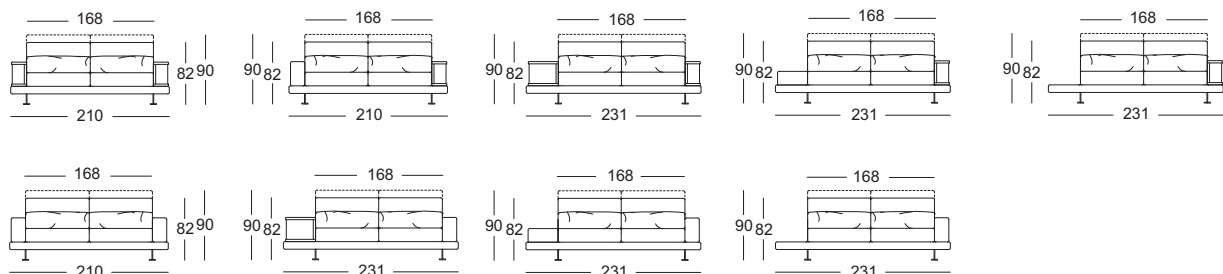

Sofa seat width 189 cm*

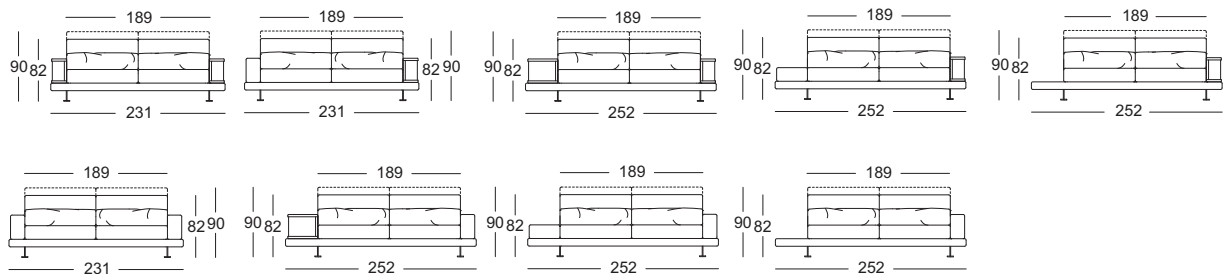

*Models are also available in a mirror-inverted version.

Sectional sofa seat width 147 cm**

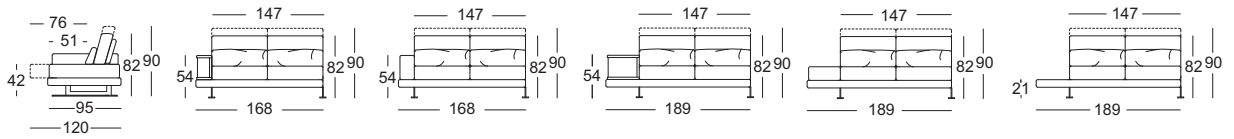

Sectional sofa seat width 168 cm**

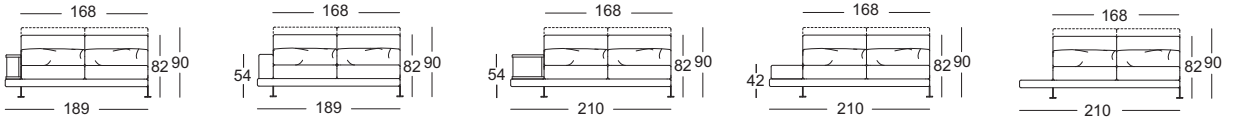

Sectional sofa seat width 189 cm**

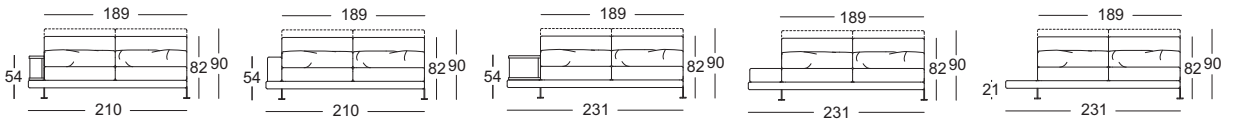

Extra-deep closing chair with fixed footstool**

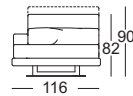
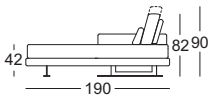

Closing chair with fixed footstool**

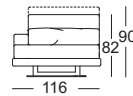
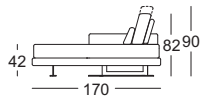

Ottoman

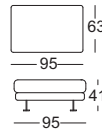

**These elements are only shown in the left version. They are also available in the right version.

Side element version

Side element
21 cm

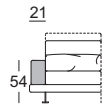

Seat cushion
42 cm

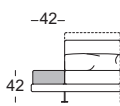

Shelf 21 cm

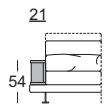

Shelf 42 cm

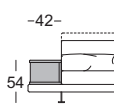

Storage 42 cm

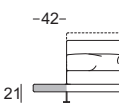

Side cushion



Back cushion

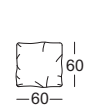

Cushion



Combination examples

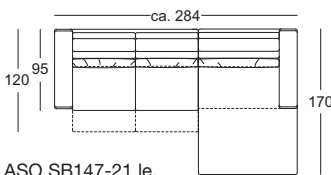

ASO SB147-21 le.
ASS-PSZ SB95-21 ri.

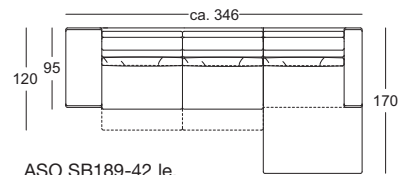

ASO SB189-42 le.
ASS-PSZ SB95-21 ri.

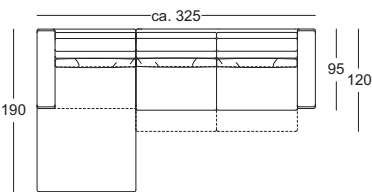

Ü-ASS-PSZ SB95-21 le.
ASO SB189-21 ri.

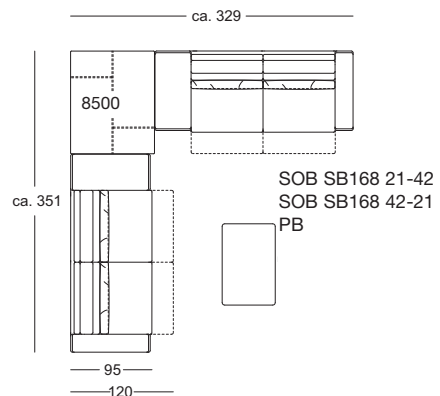

SOB SB168 21-42
SOB SB168 42-21
PB