

TECHNISCHE DATEN

# ROLF BENZ 318 LINEA

---



**ROLF  
BENZ**

- Holz-Innengestell
  - Stahlwellen-Unterfederung
  - Bezug mit Polyester-Vlies unterstept
  - Rücken aus Polyurethanschaum
  - Classic:
    - Sitz aus Polyurethanschaum, schichtweise aufgebaut in verschiedenen Höhen und Härten aufeinander abgestimmt
  - Lounge Plus:
    - Sitz aus hochwertigem Kaltschaum.
- Füße wahlweise:
- Spange Edelstahl
  - Spange lackiert
  - Verkehrsschwarz RAL 9017
- Kegelfuß wahlweise:
- Fuß Eiche H70
  - Fuß Eiche H98
  - Fuß Nussbaum H81

Classic

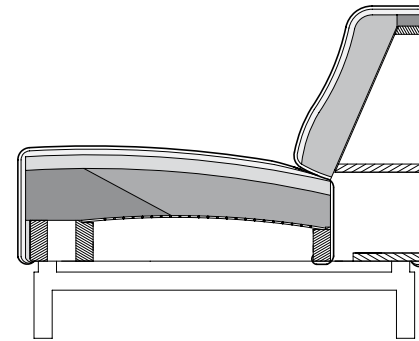

Lounge plus

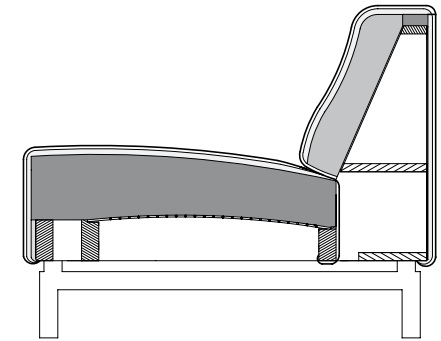

Sitzhöhen lieferbar

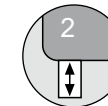

! Hochwertiger, legerer Polsteraufbau mit warentypischer Bildung von Wellen/Sitzabdrücken. Alle Maße sind Zirka-Angaben.

**ROLF  
BENZ**

Sessel

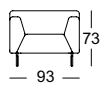

Sofabank

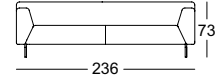
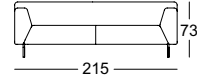
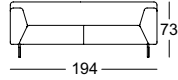
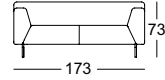
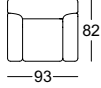

Anreihsofa\*

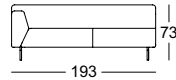
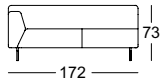

Abschlussessel mit Polstersitz\*

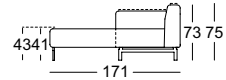

Eck-Anreihbank mit Polstersitz\*

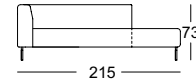
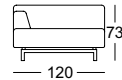

Polsterbank

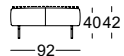
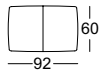

Hocker



Rückenkissen



Kombinationsbeispiel

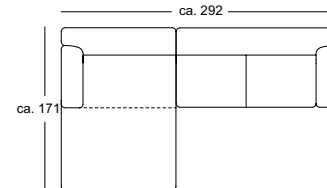

ASS-PSZ 318/120 li.  
ASO 318/172 re.

\*Diese Elemente sind in ihrer linken Ausführung abgebildet. Sie sind aber auch gespiegelt in der rechten Ausführung verfügbar.